



# VARIO30

## VARIOUS LIGHT IDEAS

### SYSTEM ŚWIETLNYCH WARIACJI

- over 30 variations and combinations
- from pendant to recessed
- housing around the powering supply
- continuous light line in angular connections
- unlimited possibilities in creating light
- ponad 30 wariantów i kombinacji
- od wiszących do wpustowych
- budowa wokół zasilania
- ciągła linia światła w połączeniach kątowych
- nieograniczone możliwości kreowania światła

an example / przykład  
variant 18

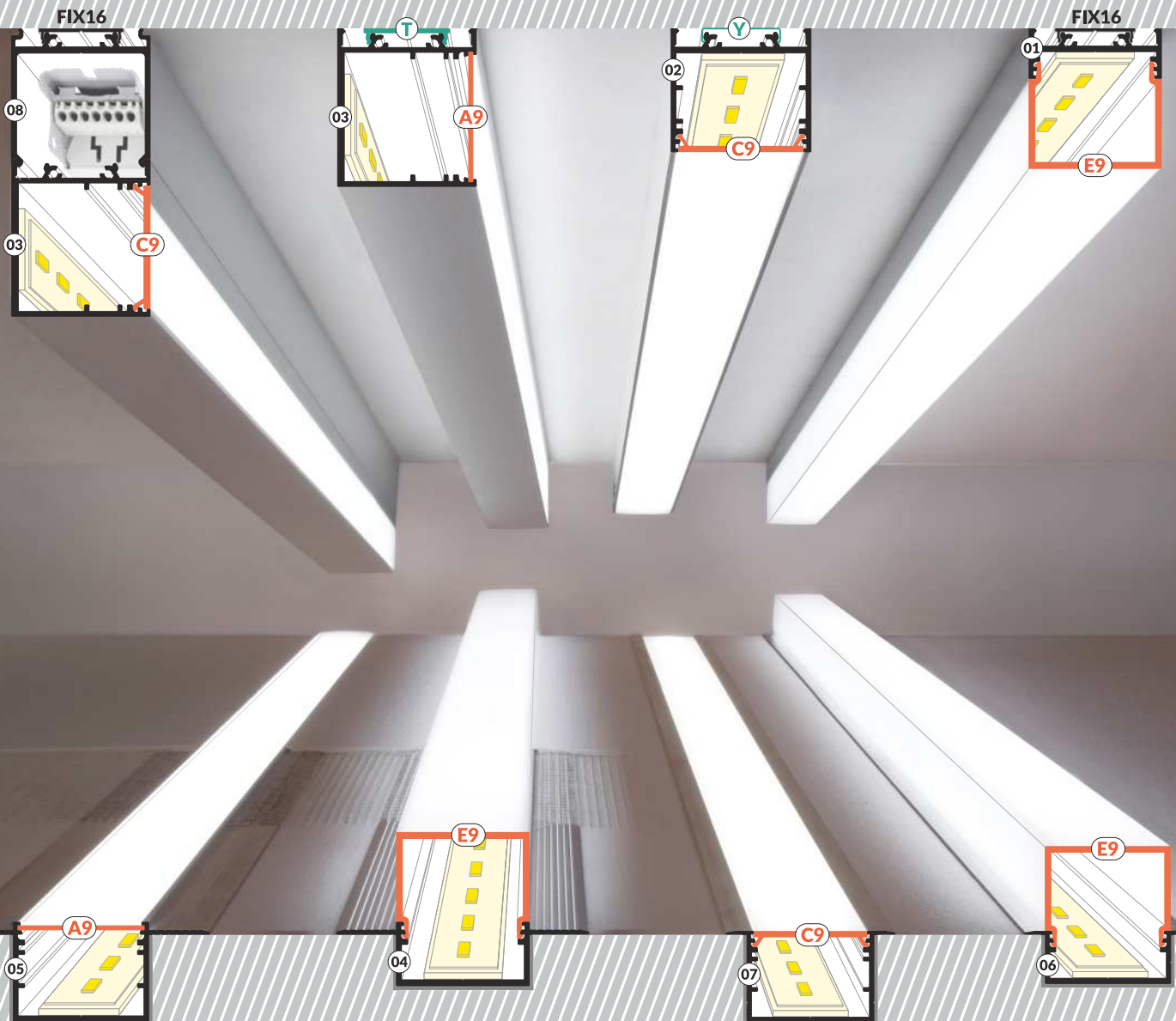
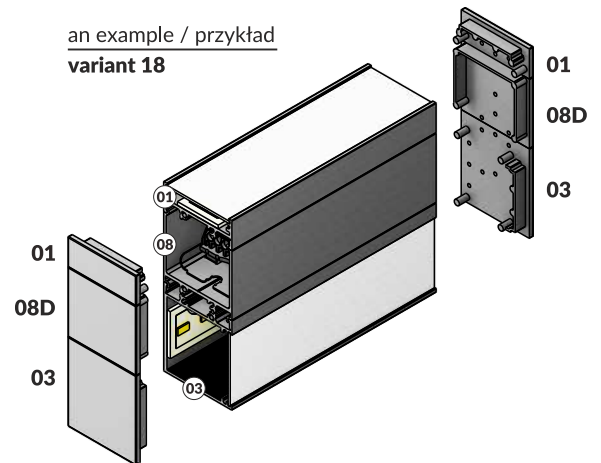

# VARIO30

11 LED profiles, 7 diffusers, 8 mountings,  
11 profili LED, 7 kloszy, 8 uchwytów

## SURFACE MOUNTED / NAWIERZCHNIOWE

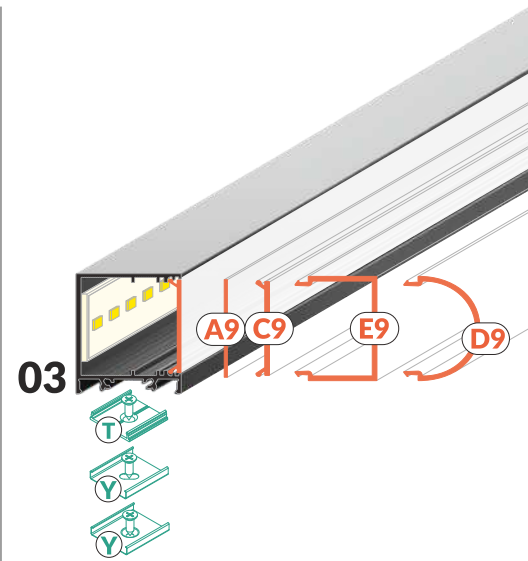
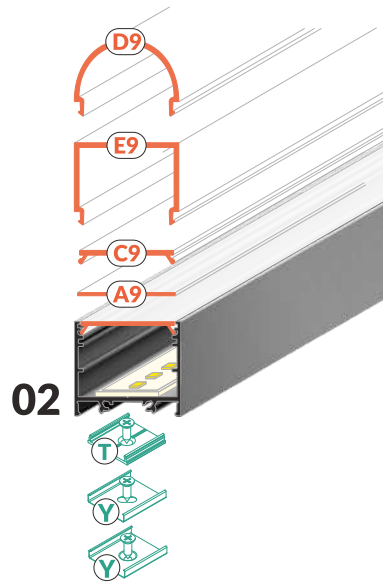
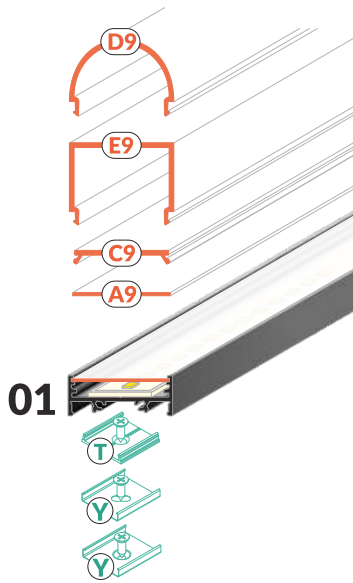

examples / przykłady

examples / przykłady

examples / przykłady

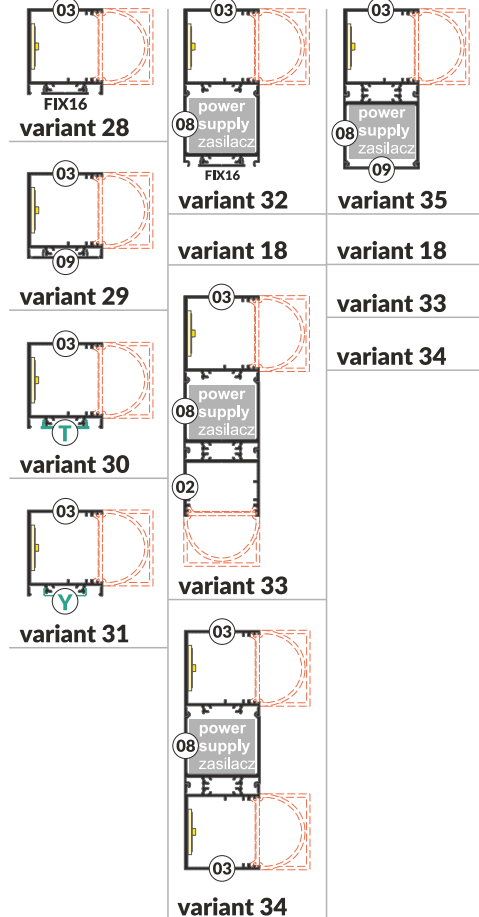
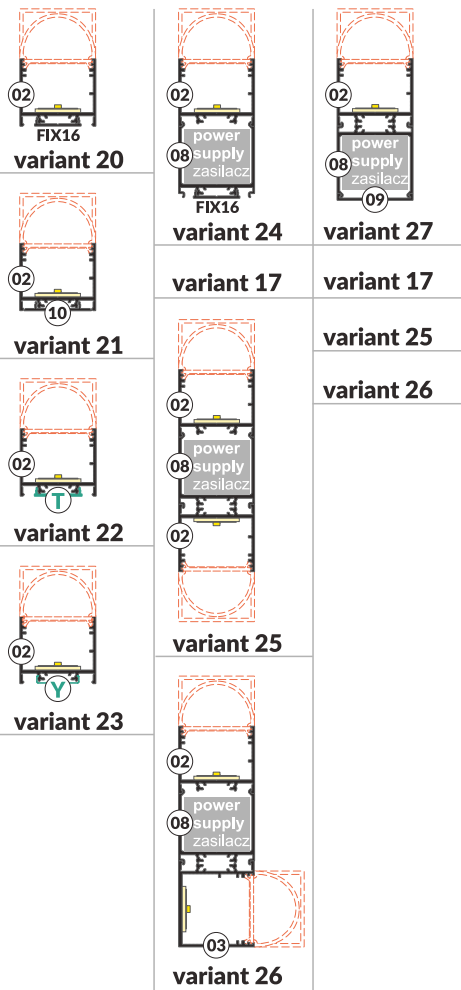
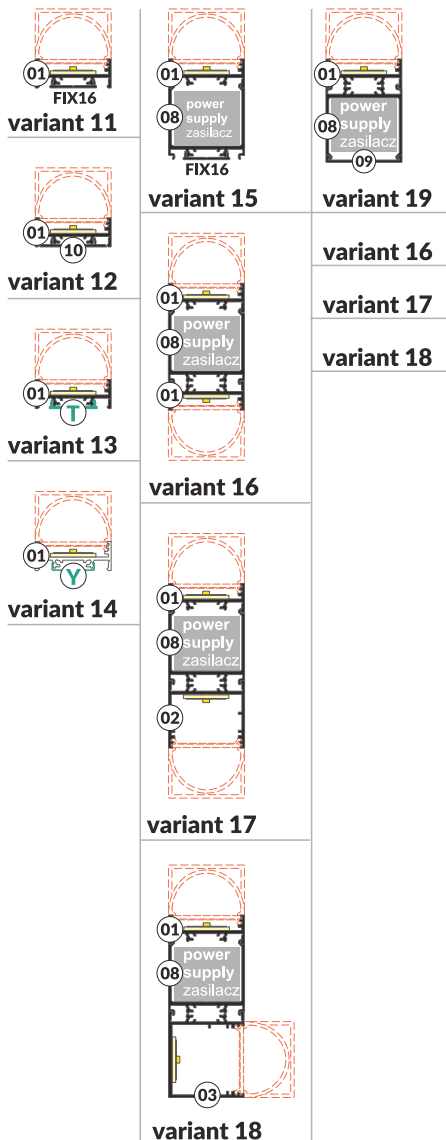

# 13 endings, 22 angular connectors 13 zaślepek, 22 uchwyty kątowe

## RECESSED SPACKLE FLANGE MOUNTED WPUSTOWE DO SZPACHLOWANIA

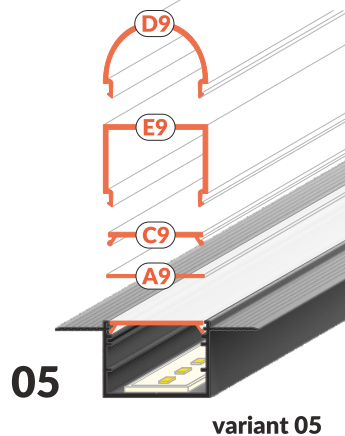
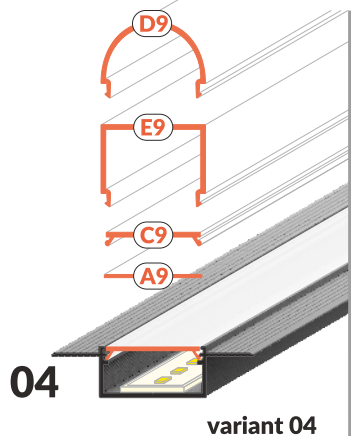

## RECESSED MOUNTED WPUSTOWE

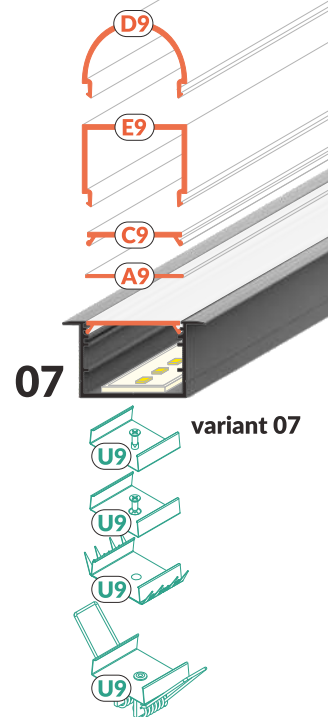
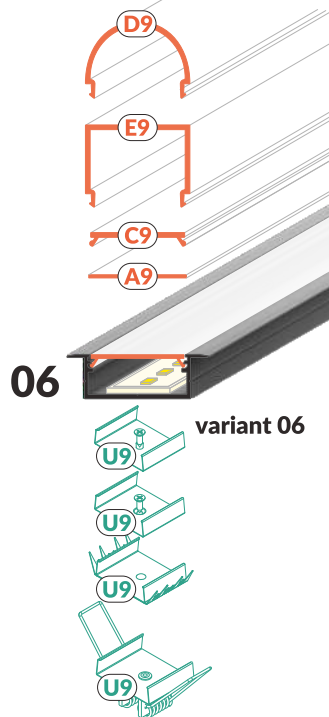

## POWER SUPPLY COVER OSŁONA ZASILACZA

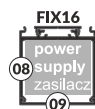

variant 36

08



## ASSISTANT PROFILES PROFILE POMOCNICZE

09



10



FIX16



### A9 SLIDE IN DIFFUSER KLOSZ A9 WSUWANY

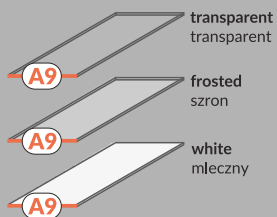

### C9 CLICK DIFFUSER KLOSZ C9 KLIK

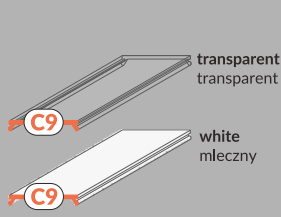

### D9 CLICK DIFFUSER KLOSZ D9 KLIK

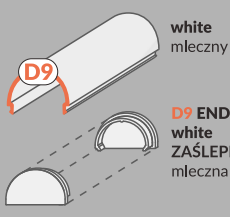

### E9 CLICK DIFFUSER KLOSZ E9 KLIK



### LED CLAMP DOCISK LED

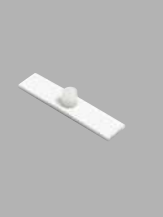

### CONNECTORS FOR PROFILES 02, 05, 07 ŁĄCZNIKI DO PROFILI 02, 05, 07

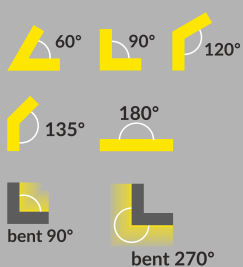

### ENDINGS FOR PROFILES ZAŚLEPKI DO PROFILI

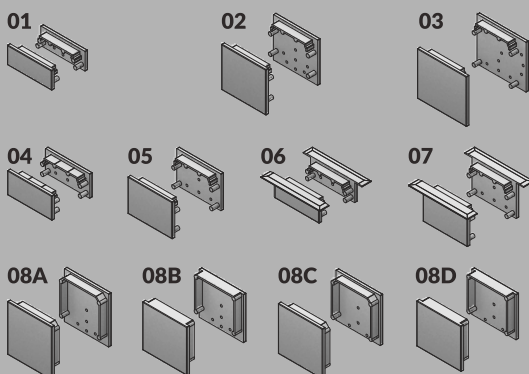

### MOUNTINGS FOR PROFILES 01, 02, 03 MOCOWANIA DO PROFILI 01, 02, 03

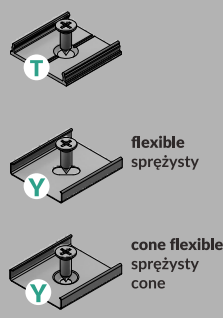

### MOUNTINGS FOR PROFILES 06, 07 MOCOWANIA DO PROFILI 06, 07

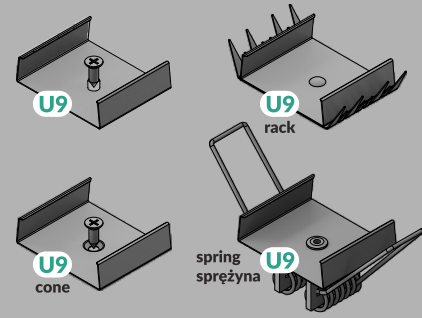

## PROMOTED VARIANTS / PROMOWANE WARIANTY

### variant 27 - pendant 09-08-02-C9

wariant 27 - wiszący 09-08-02-C9

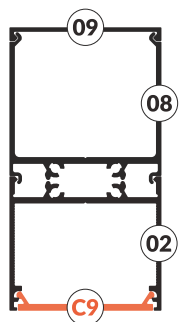

### variant 15 - ceiling FIX16-08-01-E9

wariant 15 - sufitowy FIX16-08-01-E9

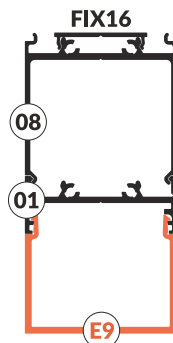

### variant 32 - wall side FIX16-08-03-B9

wariant 32 - ścienny boczny FIX16-08-03-B9

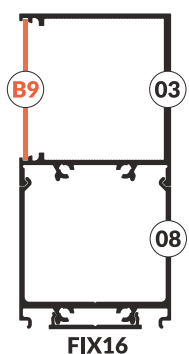

### variant 11 - furniture FIX16-01-C9

wariant 11 - meblowy FIX16-01-C9

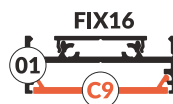

### variant 06 - recessed 06-E9

wariant 06 - wpustowy 06-E9

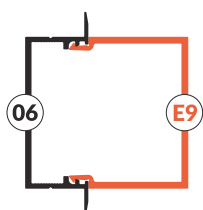

### variant 05 - recessed 05-C9 spackle mounting

wariant 05 - wpustowy 05-C9 do szpachlowania

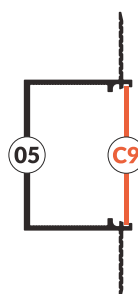





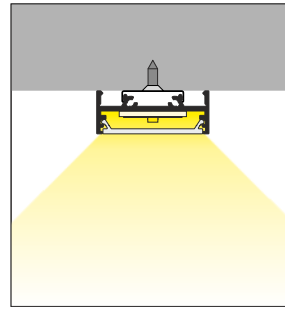
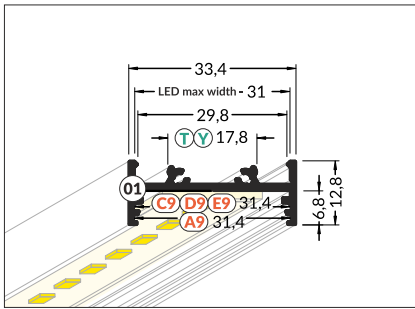

## LED profile VARIO30-01 / profil LED VARIO30-01



INDEX = 1 pc, length 2000 mm  
package = 10 pcs  
INDEKS = 1 szt., długość 2000 mm  
opakowanie = 10 szt.

-  white painted  
biały malowany V3020001
-  anodized  
anodowany V3020020
-  black anodized  
czarny anodowany V3020021
-  raw aluminium  
surowe aluminium V3020000

Available lengths / Dostępne długości  
1000 mm, 2000 mm, 3000 mm, 4000 mm

## LED profile VARIO30-02 / profil LED VARIO30-02

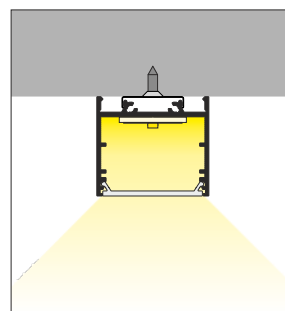
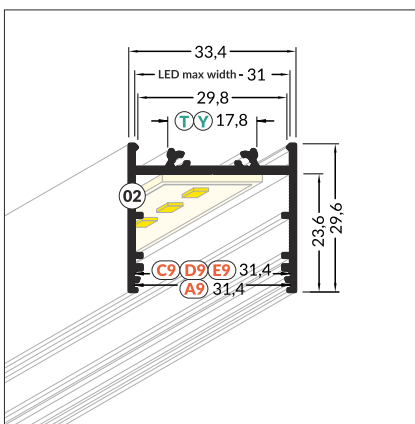

INDEX = 1 pc, length 2000 mm  
package = 10 pcs  
INDEKS = 1 szt., długość 2000 mm  
opakowanie = 10 szt.

-  white painted  
biały malowany V3060001
-  anodized  
anodowany V3060020
-  black anodized  
czarny anodowany V3060021
-  raw aluminium  
surowe aluminium V3060000

Available lengths / Dostępne długości  
1000 mm, 2000 mm, 3000 mm, 4000 mm

## LED profile VARIO30-03 / profil LED VARIO30-03

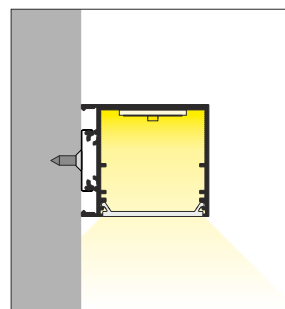
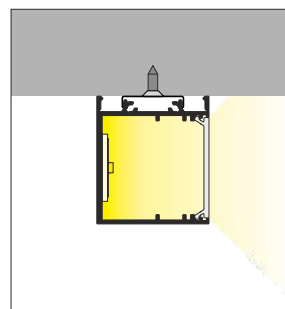
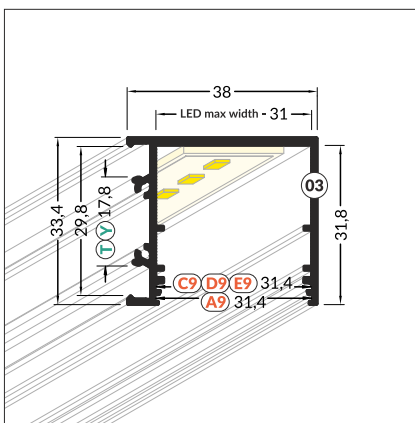

INDEX = 1 pc, length 2000 mm  
package = 10 pcs  
INDEKS = 1 szt., długość 2000 mm  
opakowanie = 10 szt.

-  white painted  
biały malowany V3100001
-  anodized  
anodowany V3100020
-  black anodized  
czarny anodowany V3100021
-  raw aluminium  
surowe aluminium V3100000

Available lengths / Dostępne długości  
1000 mm, 2000 mm, 3000 mm, 4000 mm

# RECESSED / WPUSTOWE

Available in stock  
Dostępny na magazynie



## LED profile VARIO30-04 / profil LED VARIO30-04

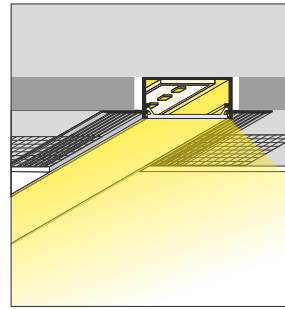
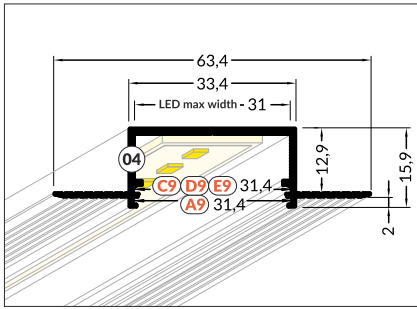

INDEX = 1 pc, length 2000 mm  
package = 10 pcs  
INDEKS = 1 szt., długość 2000 mm  
opakowanie = 10 szt.

- white painted biały malowany V3140001
- anodized anodowany V3140020
- raw aluminium surowe aluminium V3140000

Available lengths / Dostępne długości  
1000 mm, 2000 mm, 3000 mm, 4000 mm

## LED profile VARIO30-05 / profil LED VARIO30-05

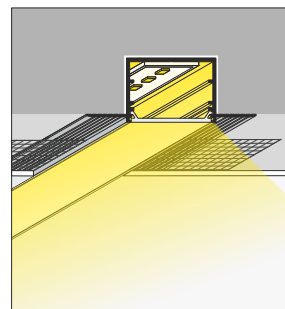
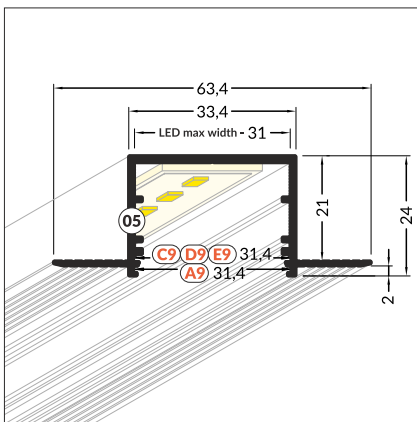

INDEX = 1 pc, length 2000 mm  
package = 10 pcs  
INDEKS = 1 szt., długość 2000 mm  
opakowanie = 10 szt.

- white painted biały malowany V3180002
- anodized anodowany V3180020
- raw aluminium surowe aluminium V3180000

Available lengths / Dostępne długości  
1000 mm, 2000 mm, 3000 mm, 4000 mm

## LED profile VARIO30-06 / profil LED VARIO30-06

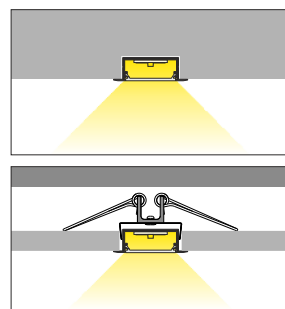
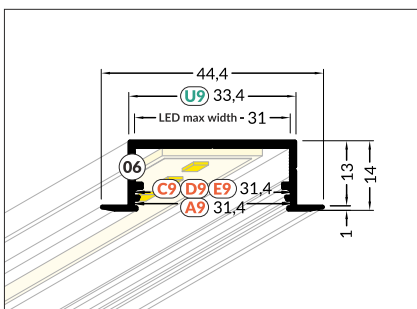

INDEX = 1 pc, length 2000 mm  
package = 10 pcs  
INDEKS = 1 szt., długość 2000 mm  
opakowanie = 10 szt.

- white painted biały malowany V3220001
- anodized anodowany V3220020
- black anodized czarny anodowany V3220021
- raw aluminium surowe aluminium V3220000

Available lengths / Dostępne długości  
1000 mm, 2000 mm, 3000 mm, 4000 mm

## LED profile VARIO30-07 / profil LED VARIO30-07

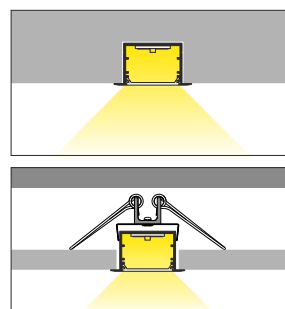
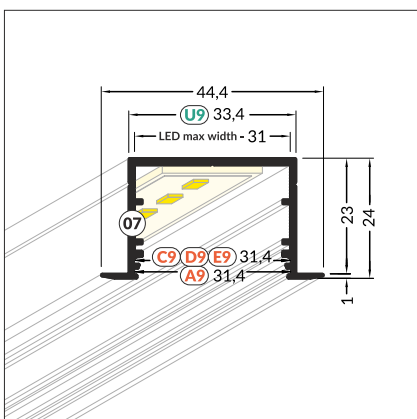

INDEX = 1 pc, length 2000 mm  
package = 10 pcs  
INDEKS = 1 szt., długość 2000 mm  
opakowanie = 10 szt.

- white painted biały malowany V3260001
- anodized anodowany V3260020
- black anodized czarny anodowany V3260021
- raw aluminium surowe aluminium V3260000

Available lengths / Dostępne długości  
1000 mm, 2000 mm, 3000 mm, 4000 mm

# POWER SUPPLY COVER / OSŁONA ZASILACZA

Available in stock  
Dostępny na magazynie



## power supply cover VARIO30-08 / osłona zasilacza VARIO30-08

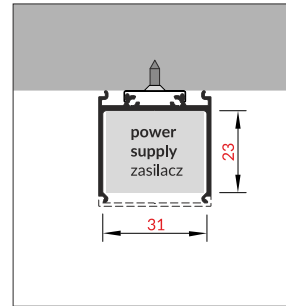
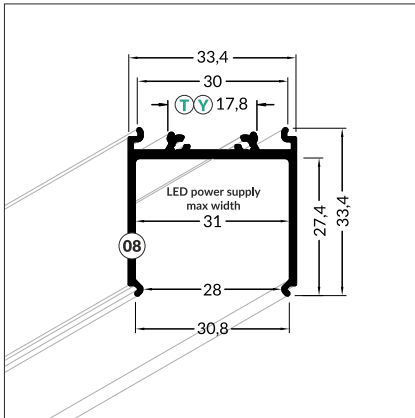

**Note!** Dimensions of the space needed to install LED power supply  
**Uwaga!** Wymiary przestrzeni do zamontowania zasilacza LED

INDEX = 1 pc, length 2000 mm  
package = 10 pcs  
INDEKS = 1 szt., długość 2000 mm  
opakowanie = 10 szt.

- white painted biały malowany V3300001
- anodized anodowany V3300020
- black anodized czarny anodowany V3300021
- raw aluminium surowe aluminium V3300000

Available lengths / Dostępne długości  
1000 mm, 2000 mm, 3000 mm, 4000 mm

# ASSISTANT PROFILES / PROFILE POMOCNICZE

Available in stock  
Dostępny na magazynie



## profile VARIO30-09 / profil VARIO30-09

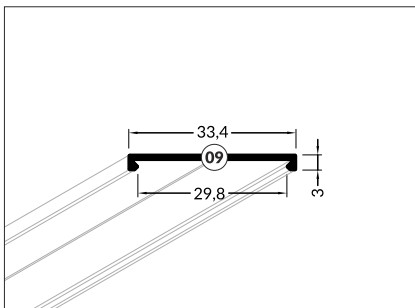

INDEX = 1 pc, length 2000 mm  
package = 10 pcs  
INDEKS = 1 szt., długość 2000 mm  
opakowanie = 10 szt.

- white painted biały malowany V3340001
- anodized anodowany V3340020
- black anodized czarny anodowany V3340021
- raw aluminium surowe aluminium V3340000

Available lengths / Dostępne długości  
1000 mm, 2000 mm, 3000 mm, 4000 mm

## profile VARIO30-10 / profil VARIO30-10

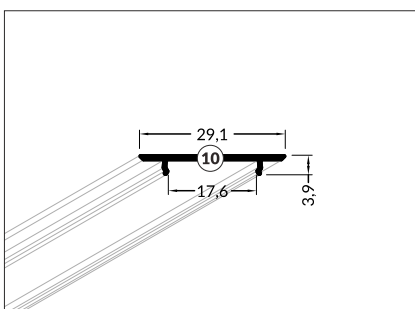

INDEX = 1 pc, length 2000 mm  
package = 10 pcs  
INDEKS = 1 szt., długość 2000 mm  
opakowanie = 10 szt.

- white painted biały malowany V3380001
- anodized anodowany V3380020
- black anodized czarny anodowany V3380021
- raw aluminium surowe aluminium V3380000

Available lengths / Dostępne długości  
1000 mm, 2000 mm, 3000 mm, 4000 mm

## profile FIX16 / profil FIX16

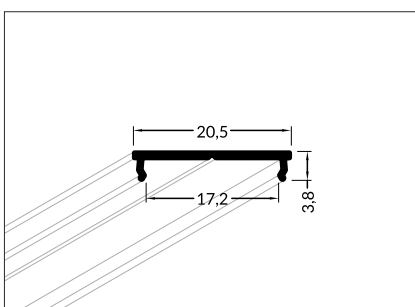

INDEX = 1 pc, length 2000 mm  
package = 10 pcs  
INDEKS = 1 szt., długość 2000 mm  
opakowanie = 10 szt.

- white painted biały malowany 6020001
- anodized anodowany 6020020
- black anodized czarny anodowany 6020021
- raw aluminium surowe aluminium 6020000

Available lengths / Dostępne długości  
1000 mm, 2000 mm, 3000 mm, 4000 mm



**A9 slide diffuser**  
colours: transparent, frosted, white  
material: PC, PP, PP

klosz A9 wsuwany  
kolory: transparentny, szron, mleczny  
materiał: PC, PP, PP



**Note!** Dimensions of the space needed to install LED source  
**Uwaga!** Wymiary przestrzeni do zamontowania źródła LED

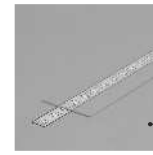
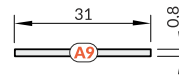
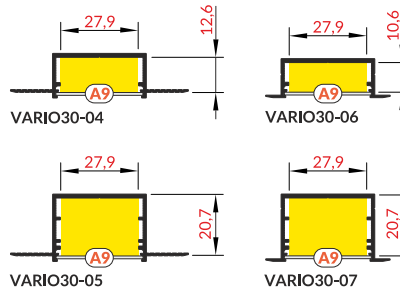
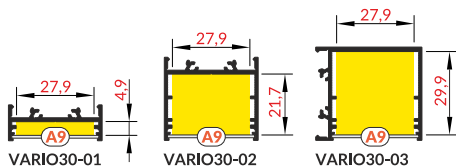

INDEX = 1 pc, length 2000 mm  
package = 10 pcs  
INDEKS = 1 szt., długość 2000 mm  
opakowanie = 10 szt.

A9 transparent / A9 transparentny  
V3420016



A9 frosted / A9 szron  
V3420039

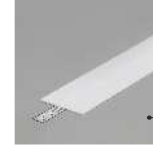

A9 white / A9 mleczny  
V3420038

**C9 click diffuser**  
colours: transparent, white  
material: PMMA

klosz C9 klik  
kolory: transparentny, mleczny  
materiał: PMMA



**Note!** Dimensions of the space needed to install LED source  
**Uwaga!** Wymiary przestrzeni do zamontowania źródła LED

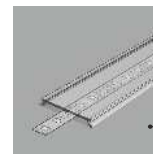
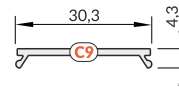
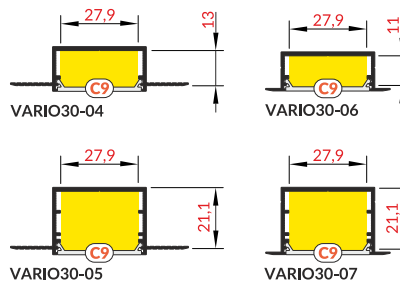
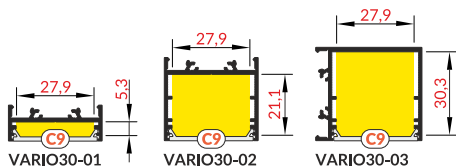

INDEX = 1 pc, length 2000 mm  
package = 10 pcs  
INDEKS = 1 szt., długość 2000 mm  
opakowanie = 10 szt.

C9 transparent / C9 transparentny  
V3460016



C9 white / C9 mleczny  
V3460038

**D9 click diffuser**  
colour: white  
material: PMMA

klosz D9 klik  
kolor: mleczny  
materiał: PMMA

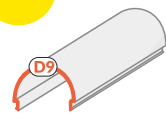

**D9 ending**  
colour: white  
material: PMMA

zaślepka D9  
kolor: mleczny  
materiał: PMMA

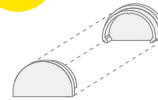

**E9 click diffuser**  
colour: white  
material: PMMA

klosz E9 klik  
kolor: mleczny  
materiał: PMMA

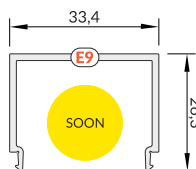

**E9 ending**  
colour: white  
material: PMMA

zaślepka E9  
kolor: mleczny  
materiał: PMMA

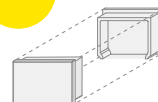

INDEX = 1 pc, length 2000 mm  
package = 10 pcs  
INDEKS = 1 szt., długość 2000 mm  
opakowanie = 10 szt.

E9 white / E9 mleczny  
V3540038



**Note!** Dimensions of the space needed to install LED source  
**Uwaga!** Wymiary przestrzeni do zamontowania źródła LED

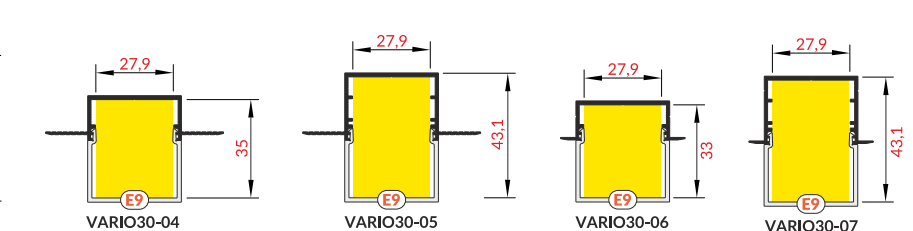
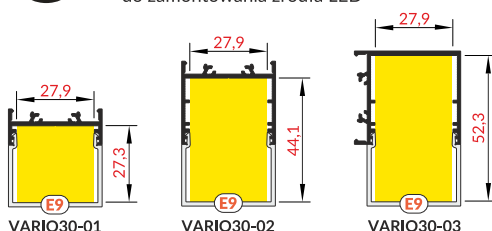



# MOUNTINGS / UCHWYTY

Available in stock  
Dostępny na magazynie



INDEX = 1 set  
package of 10 sets = 20 pcs  
INDEKS = 1 komplet, opakowanie  
zawiera 10 kompletów = 20 szt.

**Y flexible mounting plate**  
colour: inox  
material: stainless steel  
uchwyt Y sprężysty  
kolor: inox  
materiał: stal nierdzewna

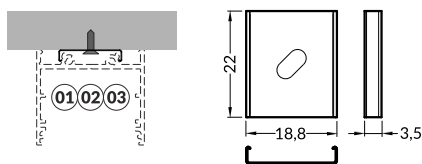

Y flexible mounting plate  
uchwyt Y

inox inox A2090019

**cone Y flexible mounting plate**  
colour: inox  
material: stainless steel  
uchwyt Y sprężysty cone  
kolor: inox  
materiał: stal nierdzewna

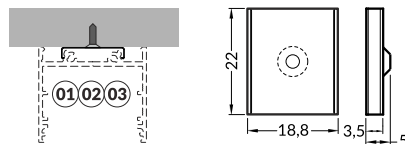

cone Y flexible mounting plate  
uchwyt Y sprężysty cone

inox inox A2130019

**T mounting plate**  
colour: raw aluminium  
material: aluminium  
uchwyt T  
kolor: surowe aluminium  
materiał: aluminium

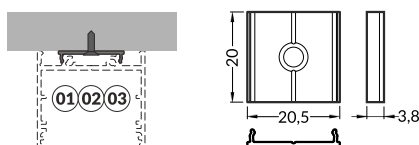

T mounting plate  
uchwyt T

raw aluminium  
surowe aluminium  
C6960000

**U9 mounting plate**  
colour: inox  
material: stainless steel  
uchwyt U9  
kolor: inox  
materiał: stal nierdzewna

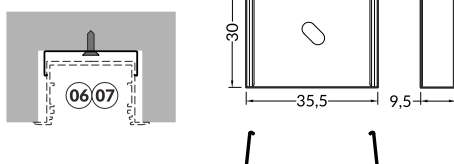

U9 mounting plate  
uchwyt U9

inox inox V4840019

**cone U9 mounting plate**  
colour: inox  
material: stainless steel  
uchwyt U9 cone  
kolor: inox  
materiał: stal nierdzewna

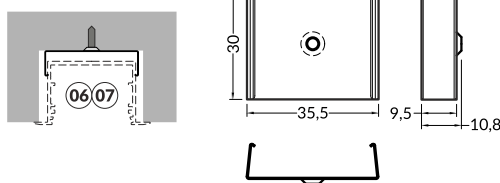

cone U9 mounting plate  
uchwyt U9 cone

inox inox V4850019

**rack U9 mounting plate**  
colour: inox  
material: stainless steel  
uchwyt U9 rack  
kolor: inox  
materiał: stal nierdzewna

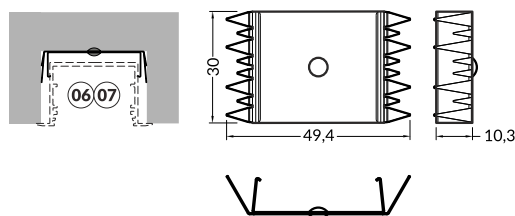

rack U9 mounting plate  
uchwyt U9 rack

inox inox V4860019

**spring U9 mounting plate**  
colour: inox  
material: stainless steel  
uchwyt U9 sprężyna  
kolor: inox  
materiał: stal nierdzewna

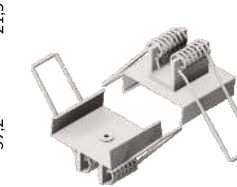
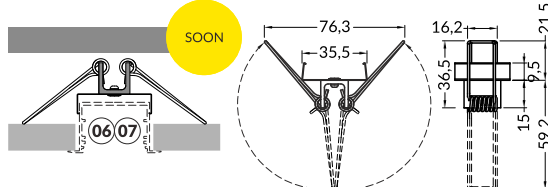

spring U9 mounting plate  
uchwyt U9 sprężyna

inox inox V4620019

# TILTED BRACKET / UCHWYT UCHYLNY

**tilted bracket**  
colours: white, silver,  
black, grey  
material: stainless steel  
uchwyt uchylny  
kolory: biały, srebrny,  
czarny, szary  
materiał: stal nierdzewna

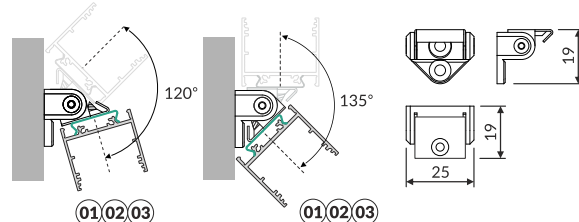

tilted bracket  
uchwyt uchylny

white biały 67230001

silver srebrny 67230040

black czarny 67230002

grey szary 67230022

 cone flexible mounting plates not included  
komplet nie zawiera uchwytów sprężystych cone

# VARIO30 ENDINGS KNOW HOW / OZNACZENIA ZAŚLEPEK VARIO30

diffuser

klosz

ending dedicated to VARIO30-08 profile

zaślepka dedykowana do profilu 08

bottom of the LED profile

dół profilu LED

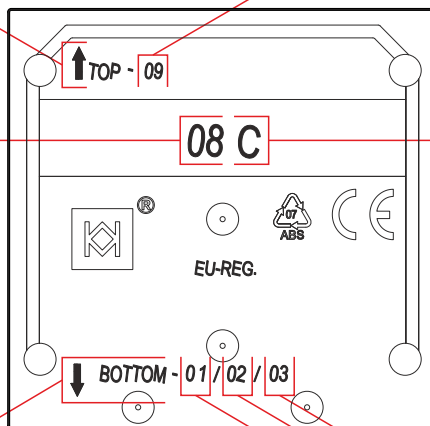

**Names of profiles fitting with chosen ending of VARIO30 system:**  
- LED profile VARIO30-09

Nazwy profili pasujących do wybranej zaślepki systemu VARIO30:  
- profil LED VARIO30-09

**type of connection variant**

typ wariantu połączeń

**Names of profiles fitting with chosen ending of VARIO30 system:**

- LED profile VARIO30-01

- LED profile VARIO30-02

- LED profile VARIO30-03

Nazwy profili pasujących do wybranej zaślepki systemu VARIO30:

- profil LED VARIO30-01

- profil LED VARIO30-02

- profil LED VARIO30-03

## AN EXAMPLE / PRZYKŁAD

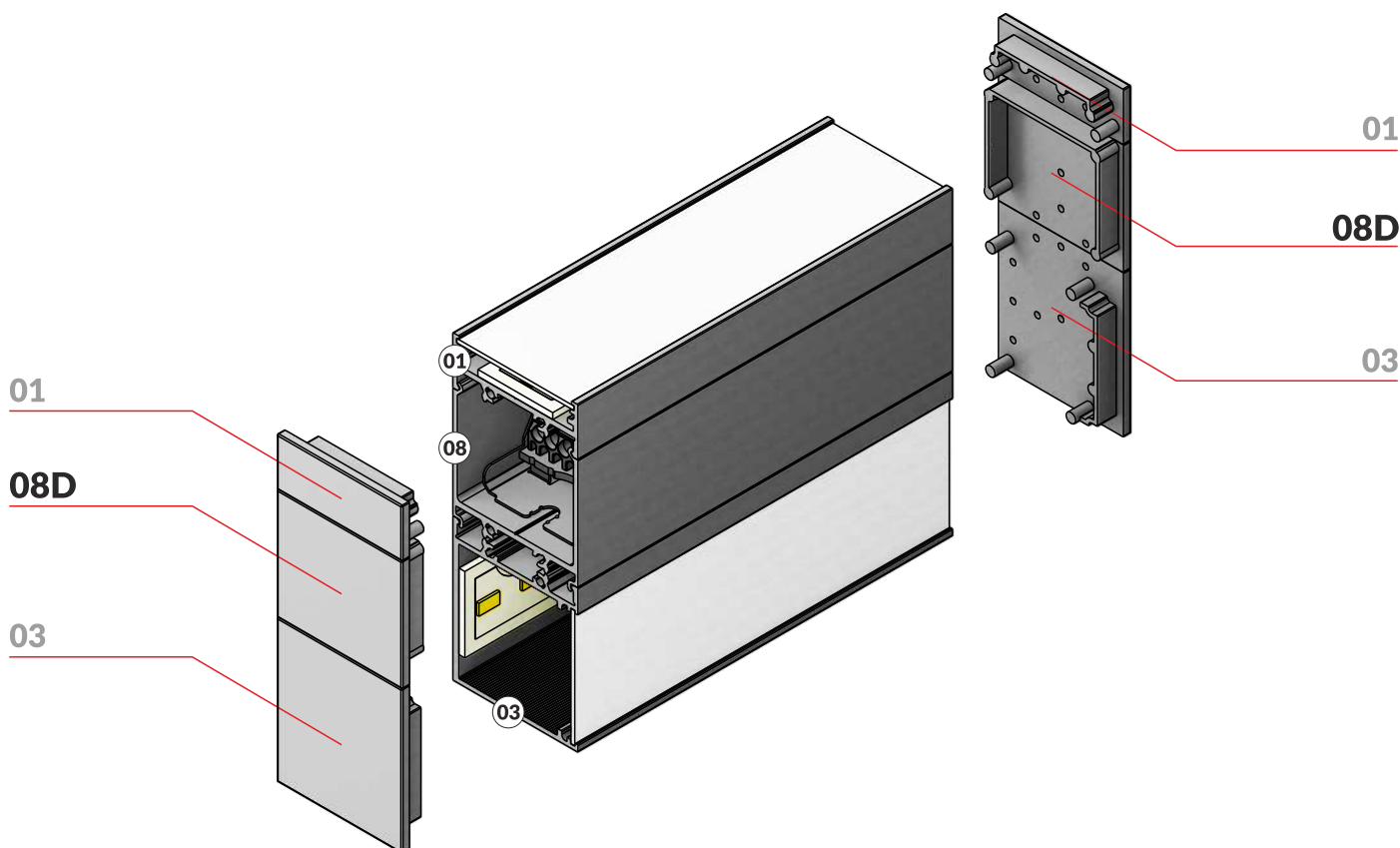



## for surface profiles/ do profili nawierzchniowych

### ENDING 01 / ZAŚLEPKA 01

**VARIO30-01 ending**  
colours: white, silver, black, grey  
material: ABS

zaślepka VARIO30-01  
kolory: biały, srebrny, czarny, szary  
materiał: ABS

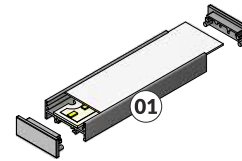
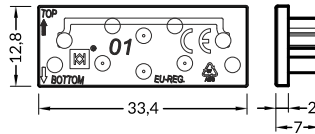

### ENDING 02 / ZAŚLEPKA 02

**VARIO30-02 ending**  
colours: white, silver, black, grey  
material: ABS

zaślepka VARIO30-02  
kolory: biały, srebrny, czarny, szary  
materiał: ABS

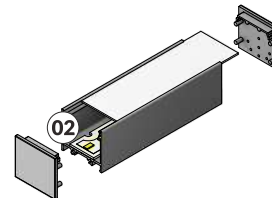
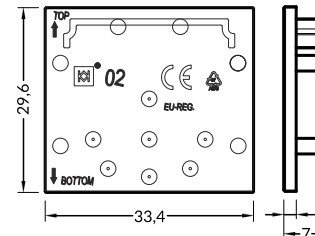

### ENDING 03 / ZAŚLEPKA 03

**VARIO30-03 ending**  
colours: white, silver, black, grey  
material: ABS

zaślepka VARIO30-03  
kolory: biały, srebrny, czarny, szary  
materiał: ABS

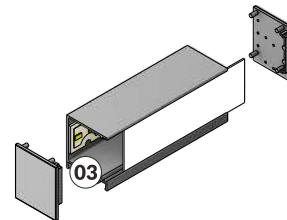
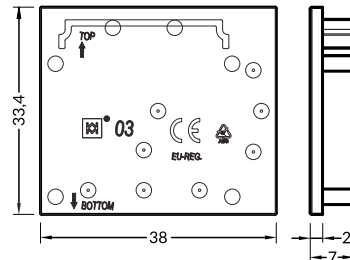

## for recessed profiles/ do profili wpustowych

### ENDING 04 / ZAŚLEPKA 04

**VARIO30-04 ending**  
colours: white, silver, grey  
material: ABS

zaślepka VARIO30-04  
kolory: biały, srebrny, szary  
materiał: ABS

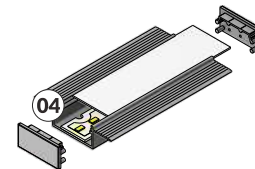
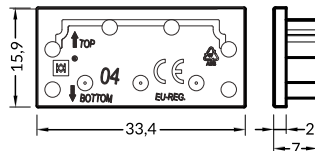

### ENDING 05 / ZAŚLEPKA 05

**VARIO30-05 ending**  
colours: white, silver, grey  
material: ABS

zaślepka VARIO30-05  
kolory: biały, srebrny, szary  
materiał: ABS

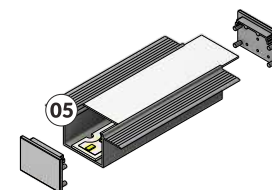
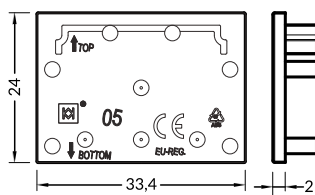

### ENDING 06 / ZAŚLEPKA 06

**VARIO30-06 ending**  
colours: white, silver, black, grey  
material: ABS

zaślepka VARIO30-06  
kolory: biały, srebrny, czarny, szary  
materiał: ABS

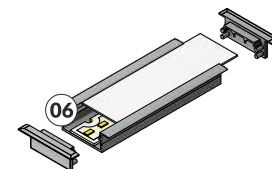
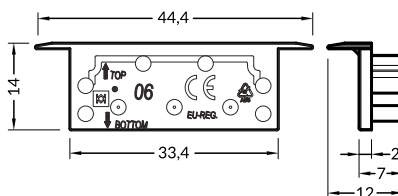

### ENDING 07 / ZAŚLEPKA 07

**VARIO30-07 ending**  
colours: white, silver, black, grey  
material: ABS

zaślepka VARIO30-07  
kolory: biały, srebrny, czarny, szary  
materiał: ABS

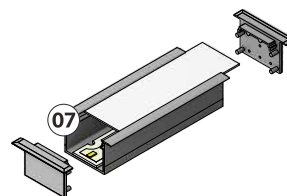
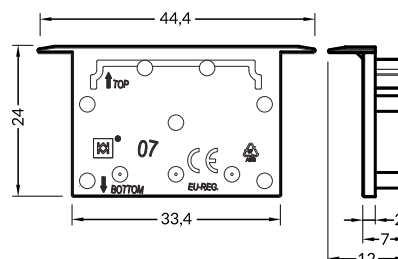

- |  |                   |          |
|--|-------------------|----------|
|  | white<br>biały    | V4870001 |
|  | silver<br>srebrny | V4870040 |
|  | black<br>czarny   | V4870002 |
|  | grey<br>szary     | V4870022 |
|  | white<br>biały    | V4880001 |
|  | silver<br>srebrny | V4880040 |
|  | black<br>czarny   | V4880002 |
|  | grey<br>szary     | V4880022 |
|  | white<br>biały    | V4890001 |
|  | silver<br>srebrny | V4890040 |
|  | black<br>czarny   | V4890002 |
|  | grey<br>szary     | V4890022 |

- |  |                   |          |
|--|-------------------|----------|
|  | white<br>biały    | V4900001 |
|  | silver<br>srebrny | V4900040 |
|  | grey<br>szary     | V4900022 |
|  | white<br>biały    | V4910001 |
|  | silver<br>srebrny | V4910040 |
|  | grey<br>szary     | V4910022 |

- |  |                   |          |
|--|-------------------|----------|
|  | white<br>biały    | V4920001 |
|  | silver<br>srebrny | V4920040 |
|  | black<br>czarny   | V4920002 |
|  | grey<br>szary     | V4920022 |

- |  |                   |          |
|--|-------------------|----------|
|  | white<br>biały    | V4930001 |
|  | silver<br>srebrny | V4930040 |
|  | black<br>czarny   | V4930002 |
|  | grey<br>szary     | V4930022 |



## for surface profiles/ do profili nawierzchniowych

### ENDING 08A / ZAŚLEPKA 08A

VARIO30-8A ending  
colours: white, silver, black, grey  
material: ABS

zaślepka VARIO30-8A  
kolory: biały, srebrny, czarny, szary  
materiał: ABS

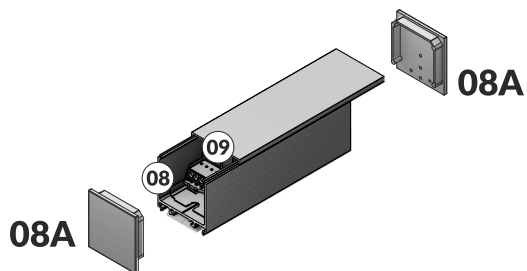
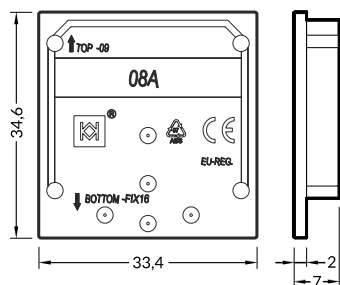

### ENDING 08B / ZAŚLEPKA 08B

VARIO30-08B ending  
colours: white, silver, black, grey  
material: ABS

zaślepka VARIO30-08B  
kolory: biały, srebrny, czarny, szary  
materiał: ABS

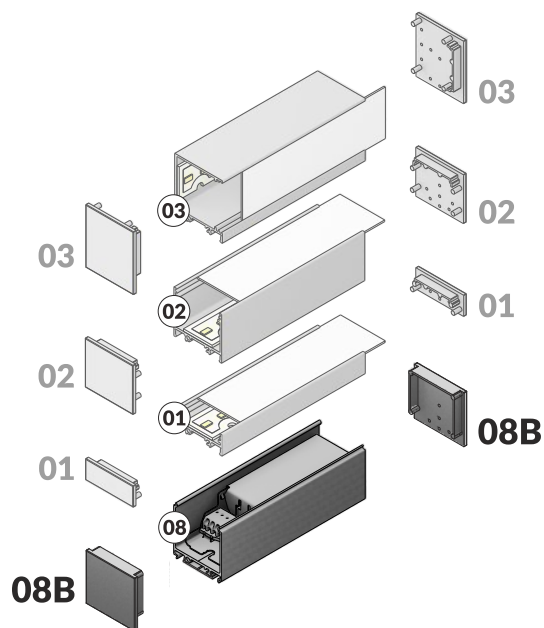
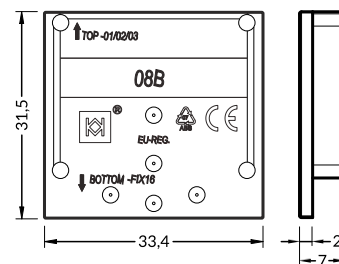



## for surface profiles/ do profili nawierzchniowych

### ENDING 08C / ZAŚLEPKA 08C

VARIO30-8C endings  
colours: white, silver, black, grey  
material: ABS

zaślepka VARIO30-8C  
kolory: biały, srebrny, czarny, szary  
materiał: ABS

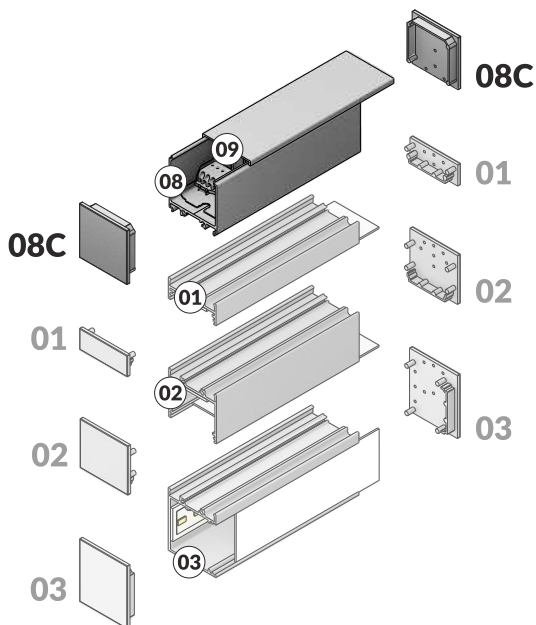
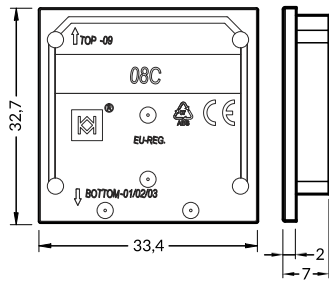

### ENDING 08D / ZAŚLEPKA 08D

VARIO30-8D endings  
colours: white, silver, black, grey  
material: ABS

zaślepka VARIO30-8D  
kolory: biały, srebrny, czarny, szary  
materiał: ABS

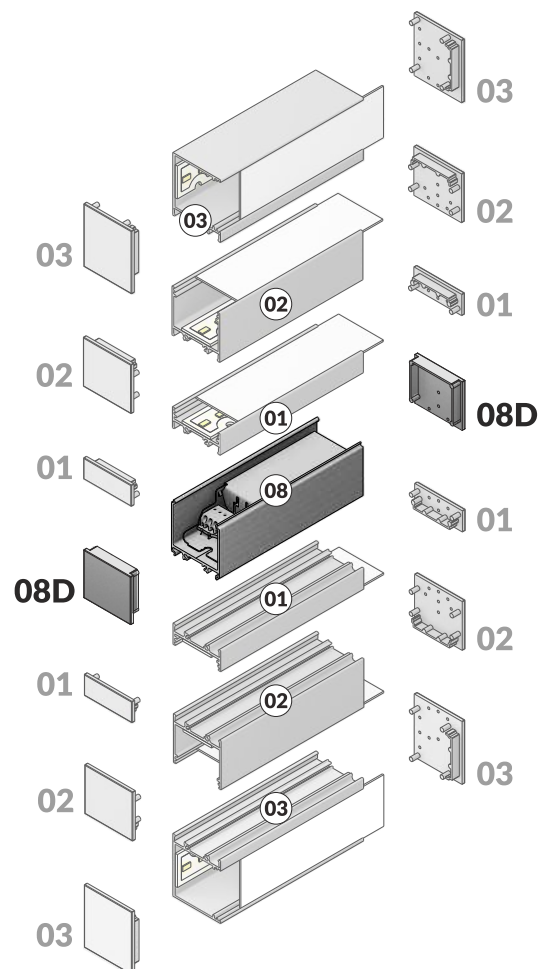
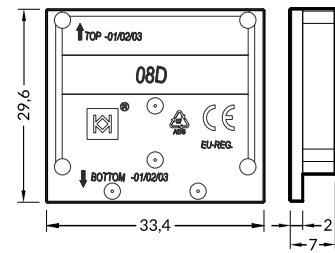

INDEX = 1 set  
1 set = 2 x 08A + 2 x 08B + 2 x 08C + 2 x 08D  
INDEKS = 1 komplet  
1 komplet zawiera = 2 x 08A + 2 x 08B + 2 x 08C + 2 x 08D

	white biały	V4600001
	silver srebrny	V4600040
	black czarny	V4600002
	grey szary	V4600022

# LED CLAMP / DOCISK LED

Available in stock  
Dostępny na magazynie



**LED clamp**  
colour: white painted  
material: steel

docisk LED  
kolor: biały malowany  
materiał: stal

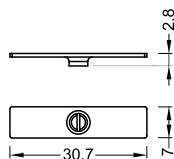
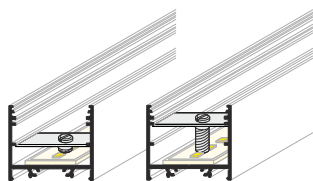

INDEX = 1 set  
package of 10 sets = 20 pcs  
INDEKS = 1 komplet, opakowanie  
zawiera 10 kompletów = 20 szt.

LED clamp  
docisk LED

 white painted  
biały malowany  
V4630001

# CONNECTORS VARIO30-02 / ŁĄCZNIKI VARIO30-02

INDEX = 1 pc  
INDEKS = 1 szt

**VARIO30-02 connector 60 deg**  
colours: white painted, anodized, black anodized  
material: aluminium, polycarbonate

łącznik VARIO30-02 60 st  
kolory: biały malowany, anodowany, czarny anodowany  
materiał: aluminium, poliwęglan

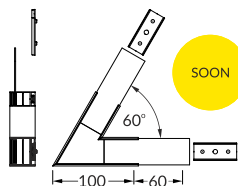

 white painted  
biały malowany V4660001s

 anodized  
anodowany V4660020s

 black anodized  
czarny anodowany V4660021s

**VARIO30-02 connector 90 deg**  
colours: white painted, anodized, black anodized  
material: aluminium, polycarbonate

łącznik VARIO30-02 90 st  
kolory: biały malowany, anodowany, czarny anodowany  
materiał: aluminium, poliwęglan

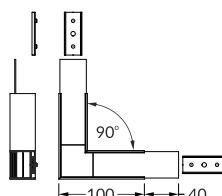

 white painted  
biały malowany V4670001s

 anodized  
anodowany V4670020s

 black anodized  
czarny anodowany V4670021s

**VARIO30-02 connector 90 deg bent**  
colours: white painted, anodized, black anodized  
material: aluminium, polycarbonate

łącznik VARIO30-02 90 st gięty  
kolory: biały malowany, anodowany, czarny anodowany  
materiał: aluminium, poliwęglan

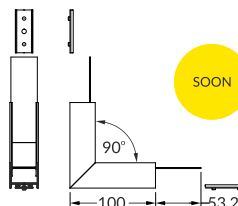

 white painted  
biały malowany V4680001s

 anodized  
anodowany V4680020s

 black anodized  
czarny anodowany V4680021s

**VARIO30-02 connector 120 deg**  
colours: white painted, anodized, black anodized  
material: aluminium, polycarbonate

łącznik VARIO30-02 120 st  
kolory: biały malowany, anodowany, czarny anodowany  
materiał: aluminium, poliwęglan

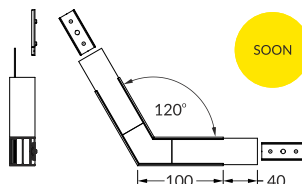

 white painted  
biały malowany V4690001s

 anodized  
anodowany V4690020s

 black anodized  
czarny anodowany V4690021s

**VARIO30-02 connector 135 deg**  
colours: white painted, anodized, black anodized  
material: aluminium, polycarbonate

łącznik VARIO30-02 135 st  
kolory: biały malowany, anodowany, czarny anodowany  
materiał: aluminium, poliwęglan

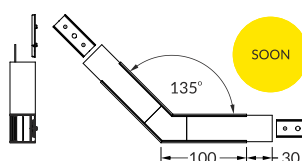

 white painted  
biały malowany V4700001s

 anodized  
anodowany V4700020s

 black anodized  
czarny anodowany V4700021s

**VARIO30-0203 connector 180 deg**  
colours: white painted, anodized, black anodized  
material: aluminium, polycarbonate

łącznik VARIO30-0203 180 st  
kolory: biały malowany, anodowany, czarny anodowany  
materiał: aluminium, poliwęglan

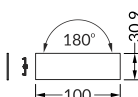

 raw aluminium  
surowe aluminium V4640000s

**VARIO30-02 connector 270 deg bent**  
colours: white painted, anodized, black anodized  
material: aluminium, polycarbonate

łącznik VARIO30-02 270 st gięty  
kolory: biały malowany, anodowany, czarny anodowany  
materiał: aluminium, poliwęglan

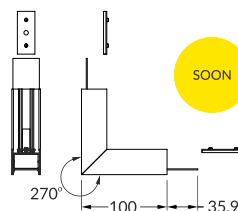

 white painted  
biały malowany V4710001s

 anodized  
anodowany V4710020s

 black anodized  
czarny anodowany V4710021s

# CONNECTORS VARIO30-03/ ŁĄCZNIKI VARIO30-03

Available in stock  
Dostępny na magazynie



**VARIO30-0203 connector 180 deg**  
colours: white painted, anodized, black anodized  
material: aluminium, polycarbonate

łącznik VARIO30-0203 180 st  
kolory: biały malowany, anodowany, czarny anodowany  
materiał: aluminium, poliwęglan

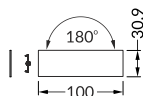

INDEX = 1 pc  
INDEKS = 1 szt

 raw aluminium  
surowe aluminium V4640000s

# CONNECTORS VARIO30-05 / ŁĄCZNIKI VARIO30-05

INDEX = 1 pc  
INDEKS = 1 szt

**VARIO30-05 connector 60 deg**  
colours: white painted, anodized  
material: aluminium, polycarbonate

łącznik VARIO30-05 60 st  
kolory: biały malowany, anodowany  
materiał: aluminium, poliwęglan

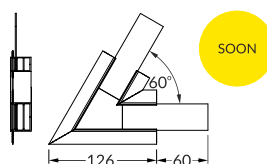



 white painted  
biały malowany V4720001s

 anodized  
anodowany V4720020s

**VARIO30-05 connector 90 deg**  
colours: white painted, anodized  
material: aluminium, polycarbonate

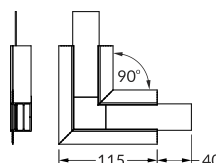
łącznik VARIO30-05 90 st  
kolory: biały malowany, anodowany  
materiał: aluminium, poliwęglan



 white painted  
biały malowany V4730001s

 anodized  
anodowany V4730020s

**VARIO30-05 connector 90 deg bent**  
colours: white painted, anodized  
material: aluminium, polycarbonate

łącznik VARIO30-05 90 st gięty  
kolory: biały malowany, anodowany  
materiał: aluminium, poliwęglan

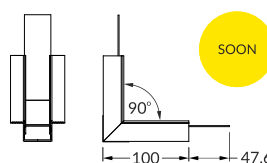



 white painted  
biały malowany V4740001s

 anodized  
anodowany V4740020s

**VARIO30-05 connector 120 deg**  
colours: white painted, anodized  
material: aluminium, polycarbonate

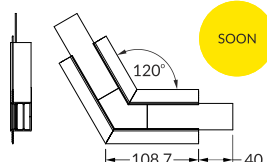
łącznik VARIO30-05 120 st  
kolory: biały malowany, anodowany  
materiał: aluminium, poliwęglan





 white painted  
biały malowany V4750001s

 anodized  
anodowany V4750020s

**VARIO30-05 connector 135 deg**  
colours: white painted, anodized  
material: aluminium, polycarbonate

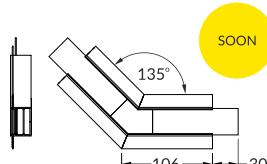
łącznik VARIO30-05 135 st  
kolory: biały malowany, anodowany  
materiał: aluminium, poliwęglan





 white painted  
biały malowany V4760001s

 anodized  
anodowany V4760020s

**VARIO30-05 connector 180 deg**  
colour: raw aluminium  
material: aluminium, polycarbonate

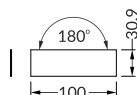
łącznik VARIO30-05 180 st  
kolor: surowe aluminium  
materiał: aluminium, poliwęglan





 raw aluminium  
surowe aluminium V4650000s

**VARIO30-05 connector 270 deg bent**  
colours: white painted, anodized  
material: aluminium, polycarbonate

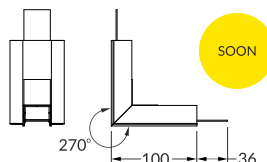
łącznik VARIO30-05 270 st gięty  
kolory: biały malowany, anodowany  
materiał: aluminium, poliwęglan



 white painted  
biały malowany V4770001s

 anodized  
anodowany V4770020s



**VARIO30-07 connector 60 deg**  
colours: white painted, anodized, black anodized  
material: aluminium, polycarbonate

łącznik VARIO30-07 60 st  
kolory: biały malowany, anodowany, czarny anodowany  
materiał: aluminium, poliwęglan

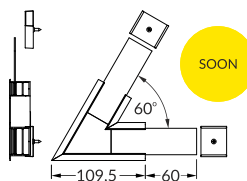

**VARIO30-07 connector 90 deg**  
colours: white painted, anodized, black anodized  
material: aluminium, polycarbonate

łącznik VARIO30-07 90 st  
kolory: biały malowany, anodowany, czarny anodowany  
materiał: aluminium, poliwęglan

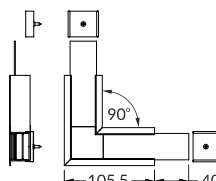

**VARIO30-07 connector 90 deg bent**  
colours: white painted, anodized, black anodized  
material: aluminium, polycarbonate

łącznik VARIO30-07 90 st gięty  
kolory: biały malowany, anodowany, czarny anodowany  
materiał: aluminium, poliwęglan

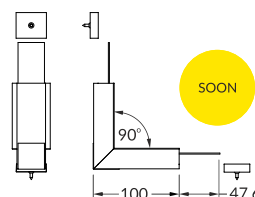

**VARIO30-07 connector 120 deg**  
colours: white painted, anodized, black anodized  
material: aluminium, polycarbonate

łącznik VARIO30-07 120 st  
kolory: biały malowany, anodowany, czarny anodowany  
materiał: aluminium, poliwęglan

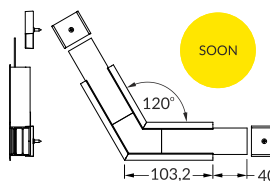

**VARIO30-07 connector 135 deg**  
colours: white painted, anodized, black anodized  
material: aluminium, polycarbonate

łącznik VARIO30-07 135 st  
kolory: biały malowany, anodowany, czarny anodowany  
materiał: aluminium, poliwęglan

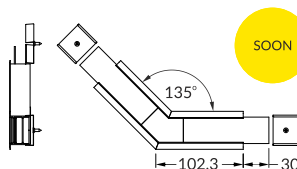

**VARIO30-07 connector 180 deg**  
colours: white painted, anodized, black anodized  
material: aluminium, polycarbonate

łącznik VARIO30-07 180 st  
kolory: biały malowany, anodowany, czarny anodowany  
materiał: aluminium, poliwęglan

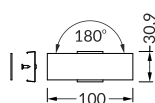

**VARIO30-07 connector 270 deg bent**  
colours: white painted, anodized, black anodized  
material: aluminium, polycarbonate

łącznik VARIO30-07 270 st gięty  
kolory: biały malowany, anodowany, czarny anodowany  
materiał: aluminium, poliwęglan

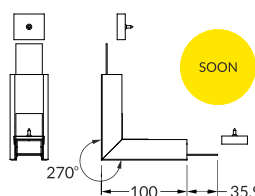

INDEX = 1 pc  
INDEKS = 1 szt

○ white painted  
biały malowany V4780001s

● anodized  
anodowany V4780020s

● black anodized  
czarny anodowany V4780021s

○ white painted  
biały malowany V4790001s

● anodized  
anodowany V4790020s

● black anodized  
czarny anodowany V4790021s

○ white painted  
biały malowany V4800001s

● anodized  
anodowany V4800020s

● black anodized  
czarny anodowany V4800021s

○ white painted  
biały malowany V4810001s

● anodized  
anodowany V4810020s

● black anodized  
czarny anodowany V4810021s

○ white painted  
biały malowany V4820001s

● anodized  
anodowany V4820020s

● black anodized  
czarny anodowany V4820021s

● raw aluminium  
surowe aluminium V4610000s

○ white painted  
biały malowany V4830001s

● anodized  
anodowany V4830020s

● black anodized  
czarny anodowany V4830021s



TOPMET LIGHT Kłósowicz Wiśniewski i Wspólnik Sp. j. ADDRESS: Ostrowska 354, 61-312 Poznań, POLAND  
tel. +48 61 87 27 500, fax. +48 61 87 27 518 biuro@topmet.pl, www.topmet.pl

The catalogue is not an offer under Polish Civil Code regulations. Colours of particular products may vary slightly from colours shown in pictures. The dimensions given are approximate and can not be a reason for complaint. TOPMET Company reserves the right to make technical changes.  
Folder nie stanowi oferty w myśl przepisów Kodeksu Cywilnego. Aktualną ofertę firmy stanowi cennik. Kolory poszczególnych produktów mogą się nieznacznie różnić od kolorów prezentowanych na zdjęciach. Podane wymiary są wymiarami orientacyjnymi i nie mogą stanowić podstawy reklamacji. Firma TOPMET zastrzega sobie prawo do wprowadzania zmian technicznych.

brochure designer • proj. folderu: M. Kędziora, A. Szafran 12.2016. photo • fot. A. Szafran, L. Wesołowski